

15 Amp - Rack Panel Mount (1583 with Surge Protection)

1583 "S" Series

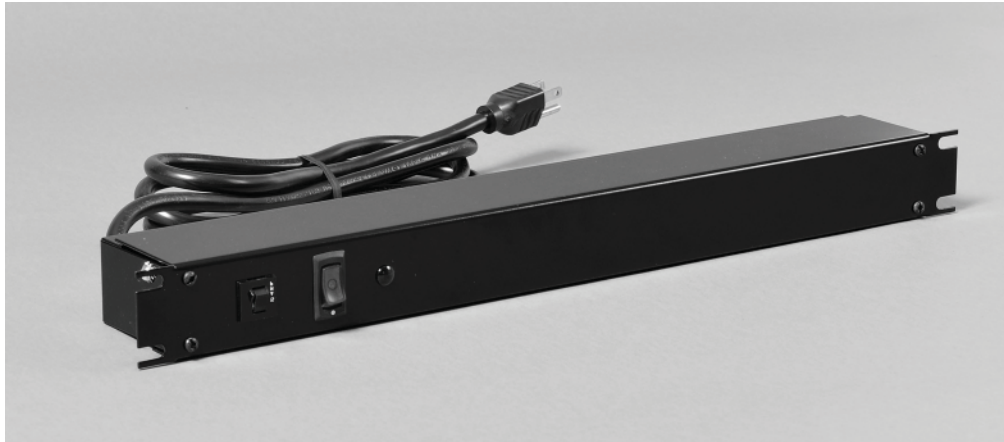

Key Features

- Same features as 1583 except with our surge module included.
- 12,000 Amp rated MOV's.
- Maximum 36,000 Amps transient current and 780 Joules.
- 400V UL1449 suppressed voltage rating.
- Protection in all 3 AC modes, L-N, N-G and L-G.
- Voltage suppression at the outlet guards against transients from equipment on the power bar.
- CSA certified, Standards C22.2 (No. 21-95, No. 42-99 and No. 8-M1986)
- UL recognized, Standards UL1363, UL1449 and UL1283

Part No.	Color	Outlets	On-Off Switch	Pilot Light	Cord Length	Plug Type
1583H6A1S	ASA 61 Grey	6	Yes	-	6'	Straight
1583H6B1S	ASA 61 Grey	6	Yes	-	15'	Straight
1583H6C1S	ASA 61 Grey	6	Yes	-	6'	Twist-Lock
1583H6D1S	ASA 61 Grey	6	Yes	-	15'	Twist-Lock
1583H6A1SBK	Black	6	Yes	-	6'	Straight
1583H6B1SBK	Black	6	Yes	-	15'	Straight
1583H6C1SBK	Black	6	Yes	-	6'	Twist-Lock
1583H6D1SBK	Black	6	Yes	-	15'	Twist-Lock



Outlet Strips with Surge Protection

NOTES

MATERIAL - 20 GAUGE SHEET METAL (BACK)
 - 16 GAUGE SHEET METAL (FRONT)

-LIGHTED ON/OFF SWITCH, 15 AMP CIRCUIT BREAKER
 -6', 14 GAUGE WIRE CORD
 -ASA 61 GREY
 -CSA CERTIFIED
 -UL RECOGNIZED

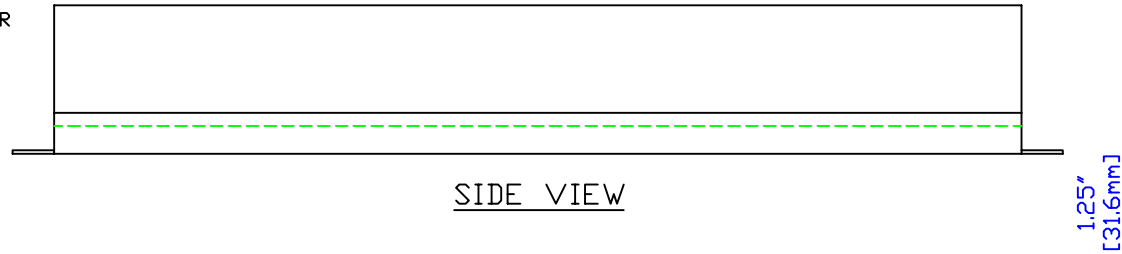

SIDE VIEW

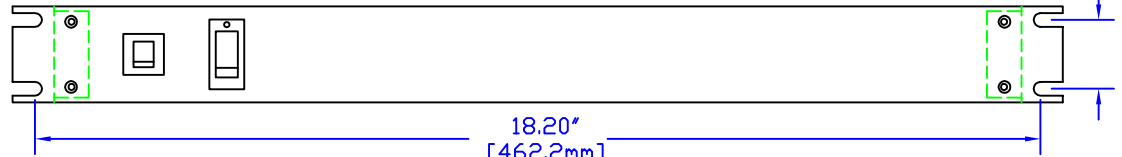

TOP VIEW

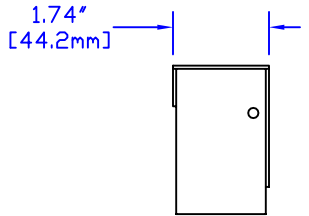

L. END VIEW

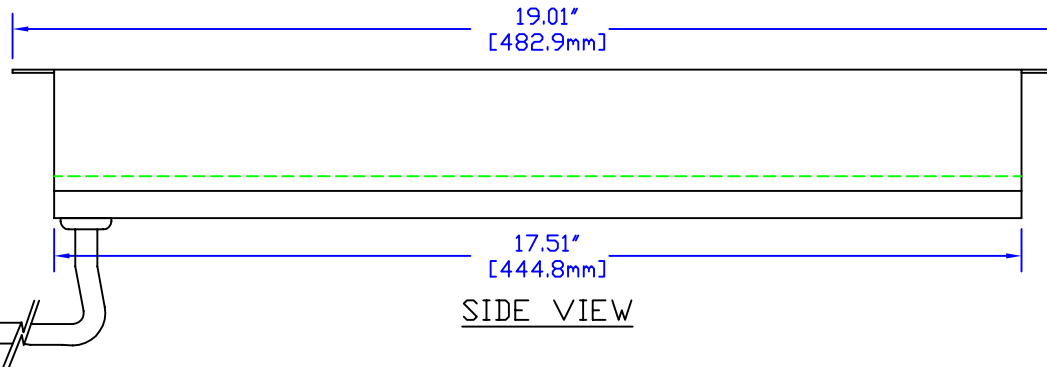

SIDE VIEW

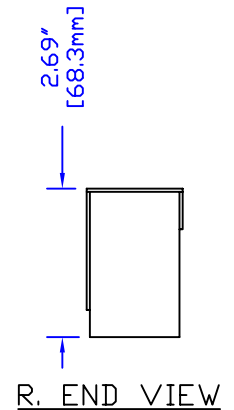

R. END VIEW

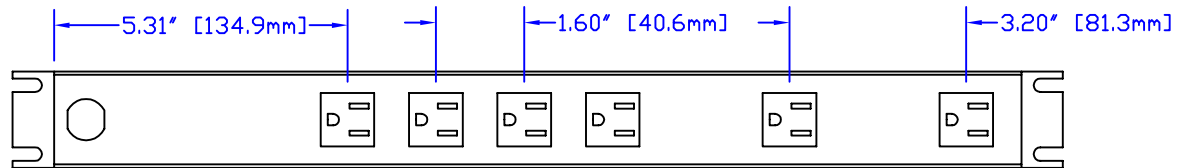

BOTTOM VIEW

-ALSO AVAILABLE IN SATIN BLACK - #1583H6A1BK
 -ALSO AVAILABLE WITH 15' WIRE CORD - #1583H6B1, #1583H6B1BK
 -ALSO AVAILABLE WITH 6' TWIST LOCK CORD - #1583H6C1, #1583H6C1BK
 -ALSO AVAILABLE WITH 15' TWIST LOCK CORD - #1583H6D1, #1583H6D1BK
 -ALSO AVAILABLE WITH SURGE PROTECTION - #1583H6A1S, #1583H6A1SBK, 1583H6B1S, 1583H6B1SBK

- FOR ANY MODIFICATIONS PLEASE PHONE OR
 FAX FOR AN IMMEDIATE QUOTATION.



HAMMOND MANUFACTURING

1583H6A1